

SYSTEM

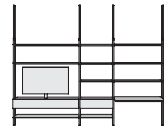

IL SISTEMA BREVETTATO EXTENDO È FORMATO DA DUE PROFILI IN ALLUMINIO ESTENSIBILI, ADATTABILI ALLE DIVERSE ALTEZZE DEGLI AMBIENTI. AGENDO SULLA LEVA A SCOMPARSA, I PROFILI SI BLOCCANO ALL'ALTEZZA DESIDERATA E SI COMPRIMONO TRA PAVIMENTO E SOFFITTO, SENZA L'UTILIZZO DI ALCUN UTENSILE O PRE-FISSAGGIO.

The patented extendo system consists of two extendable aluminium profiles that can be adapted to environments of various heights. Using the foldaway lever, the profiles can be blocked at the desired height and compressed between floor and ceiling, without having to use any kind of pre-fixing tool.

Le système breveté extendo est constitué de deux profilés extensibles en aluminium pouvant être adaptés aux différentes hauteurs des milieux. En agissant sur le levier escamotable, les profilés se verrouillent à la hauteur souhaitée et se compriment entre plancher et plafond, sans utiliser aucun outil ou préfixation.

Das patentierte System extendo besteht aus zwei ausziehbaren Aluminium-Profilen, die an unterschiedliche Raumhöhen angepasst werden können. Durch einen versenkbaren Hebel werden die Profile auf der gewünschten Höhe blockiert und zwischen Fußboden und Zimmerdecke ohne Werkzeug oder Vor-Befestigung komprimiert eingesetzt.

El sistema patentado extendo está formado por dos perfiles de aluminio extensibles, adaptables a las distintas alturas de los ambientes. Actuando sobre la palanca escondida, los perfiles se bloquean a la altura deseada y se comprimen entre el suelo y el techo, sin que sea necesario utilizar ninguna herramienta o fijación previa.

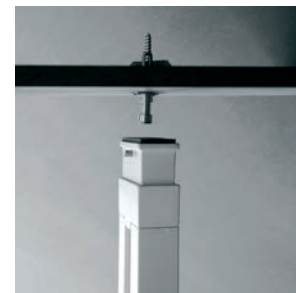
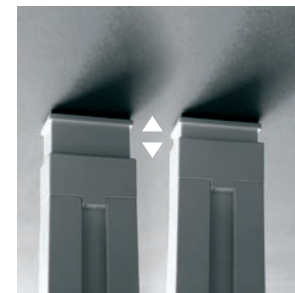
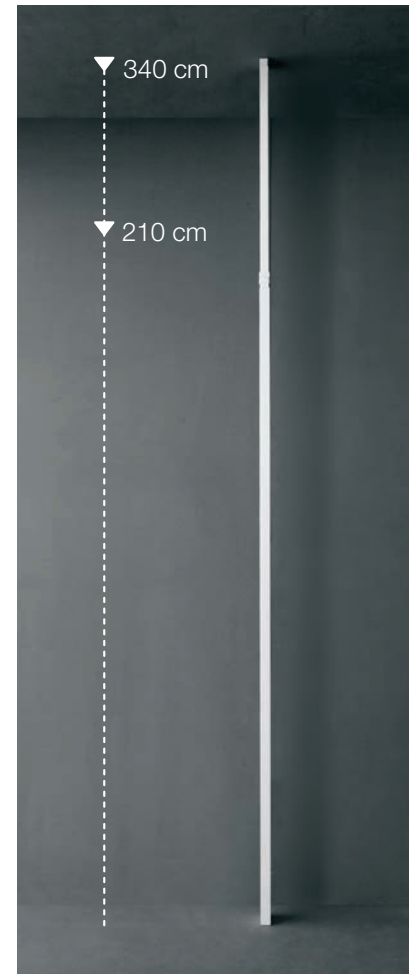

PRODUCT CONCEPT

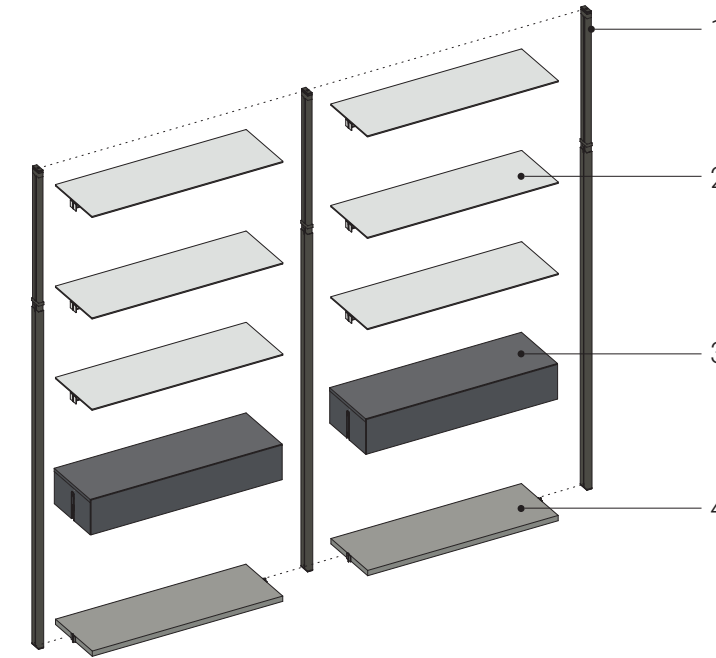

L modules
36 - 72 - 108 - 144

H modules
210 / 400

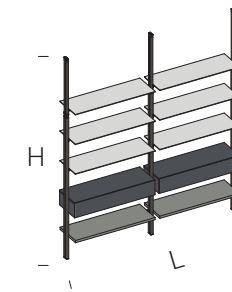

Ripiani e contenitori hanno libera posizione in altezza, (al centimetro).

Shelves and containers can be positioned at any height (to the centimetre).

Les étagères et les conteneurs peuvent être positionnés librement en hauteur (au centimètre près).

Einlegeböden und Behälter sind in der Höhe frei einsetzbar (auf den Zentimeter).

Los estantes y contenedores tienen una altura libre (al centímetro).

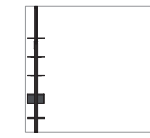

Pavimento / soffitto
Floor / ceiling
Sol / plafond
Boden / Decke
Suelo/techo

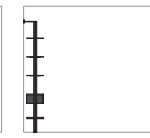

Pavimento / parete
Floor / wall
Sol / mur
Boden / Wand
Suelo / pared

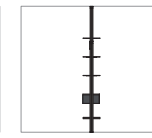

Bifacciale
Double-sided
Double face
Zweiseitig
Doble cara

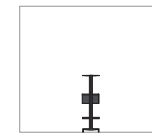

Pavimento / bifacciale
Floor / Double-sided
Sol / Double face
Boden / Zweiseitig
Suelo / Doble cara

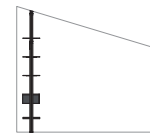

Soffitto inclinato
Sloping ceiling
Plafond incliné
Schräge Decke
Techo inclinado



Riduzioni a misura disponibili su profili verticali e ripiani.
Measurement reductions available on vertical profiles and shelves.

Réductions sur mesure possibles pour les profilés verticaux et les étagères.
Verkürzung nach Kundenwunsch auf vertikalen Profilen und Einlegeböden.
Reducciones de tamaño disponibles en los perfiles verticales y los estantes.



Passacavi disponibili su contenitori.
Cable sleeves available on containers.

Des passe-câbles sont disponibles sur les conteneurs.
Kabeldurchgänge auf Behälter verfügbar.
Pasacables disponibles en los contenedores.

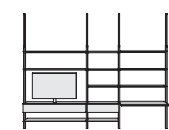

Profilo telescopico brevettato
Patented telescopic profile
Profilé télescopique breveté
Patentiertes teleskopisches Profil
Perfil telescópico patentado



I profili in alluminio estruso, sono configurabili per adattarsi alle diverse esigenze degli ambienti. Sono infatti possibili configurazioni per installazioni a soffitto, parete, bifacciale e soffitto inclinato.

The extruded aluminium profiles are modular, to adapt to the needs of the spaces. Indeed, configurations are available for ceiling, wall, double-sided and sloping ceiling mounting.

Les profilés en aluminium extrudé peuvent être configurés pour s'adapter aux différents besoins des espaces. En effet, des configurations pour des installations au plafond, au mur, en double face et sur plafond incliné sont possibles.

Die Profile aus extrudiertem Aluminium sind gestaltbar, um sich an die verschiedenen Anforderungen der Räume anzupassen. Es sind nämlich Konfigurationen für die Montage an der Decke, an der Wand, zwei-seitig und an schräger Decke möglich.

Los perfiles de aluminio extruido pueden configurarse para adaptarse a los diferentes requisitos de la sala. De hecho, son posibles configuraciones para instalaciones en el techo, en la pared, en la bifaz y en el techo inclinado.



I contenitori, disponibili in essenza e laccato, sono configurabili con frontali in HPL o vetro temprato, di soli 4mm di spessore. La semplificazione delle geometrie rende il volume compatto e raffinato.

The containers, available in wood and lacquered, can have HPL or tempered glass fronts with a thickness of just 4 mm. The simplicity of the geometries makes the unit compact and elegant.

Les conteneurs, disponibles en bois et laqués, peuvent être configurés avec des façades en HPL ou en verre trempé de seulement 4 mm d'épaisseur. La simplification des géométries rend le volume compact et épuré.

Die Behälter sind aus Holznachbildung oder lackiert verfügbar und sind mit der Stirnseite aus HPL oder Hartglas mit einer Stärke von nur 4 mm konfigurierbar. Die Vereinfachung der Formen machen das Volumen kompakt und raffiniert.

Los contenedores, disponibles en madera y lacados, pueden configurarse con frentes de HPL o de vidrio templado, de sólo 4 mm de grosor. La simplificación de las geometrías hace que el volumen sea compacto y refinado.

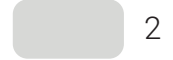

I ripiani a modulo dallo spessore ridottissimo 6/10 mm sono costruiti in HPL o vetro temprato. In entrambe le soluzioni sono accoppiati a profili in acciaio per aumentarne la resistenza ai carichi e all'indeformabilità.

The module shelves, with an extremely small thickness 6/10 mm, are made of HPL or tempered glass. In both solutions they are coupled to steel profiles to increase their resistance to loads and improve dimensional stability.

Les étagères modulables de très faible épaisseur (6/10 mm) sont en HPL ou en verre trempé. Dans les deux solutions, elles sont couplées à des profilés en acier pour augmenter leur résistance aux charges et leur propriété d'indéformabilité.

Die Modul-Einlegeböden mit einer reduzierten Dicke von 6/10 mm sind aus HPL oder aus Hartglas. In beiden Lösungen sind sie mit Stahlprofilen verbunden, um die Belastbarkeit und die Umformfestigkeit zu erhöhen.

Los estantes modulares de 6/10 mm de grosor son de HPL o de vidrio templado, y en ambas soluciones se acoplan con perfiles de acero para aumentar su resistencia a las cargas y su indeformabilidad.



I ripiani in multistrato bilaminato spessore 3cm, rappresentano un'ottima soluzione per ottenere un ripiano leggero e resistente ai carichi, riducibile in lunghezza e profondità.

The 3 cm thick bi-laminated multi-layer shelves are an ideal solution for a light, load resistant shelf with a reduced length and depth.

Les étagères en contreplaqué bi-laminé de 3 cm d'épaisseur sont une excellente solution pour obtenir une étagère légère et résistante à la charge, avec possibilité de réduction en longueur et en profondeur.

Die beidseitig belegten Einlegeböden aus 3 cm dickem Mehrschichtholz sind eine optimale Lösung für einen leichten und belastbaren Einlegeboden, verkürzbar in Länge und Tiefe.

Los estantes de madera contrachapada de 3 cm de grosor son una excelente solución para obtener una estantería ligera y resistente a la carga que puede reducirse en longitud y profundidad.

FINITURE/FINISHES

profilo extendo / extendo profile

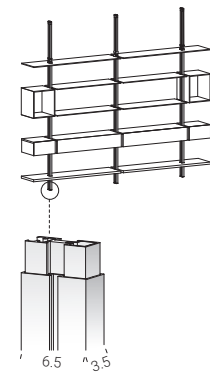

alluminio verniciato
painted aluminium



ripiani in multistrato / multilayer shelves

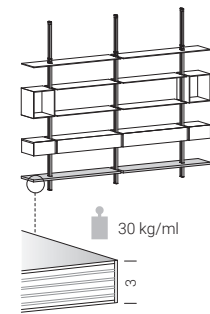

multistrato laccato
lacquered multilayer



ripiani in vetro / glass shelves

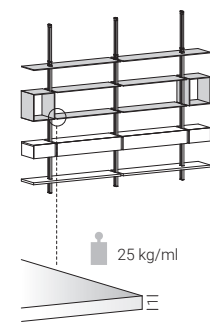

vetro laccato
tempered glass



vetro trasparente
transparent glass



DIMENSIONI/DIMENSIONS

verificare a listino dimensioni e finiture
check dimensions and finishes in the price list

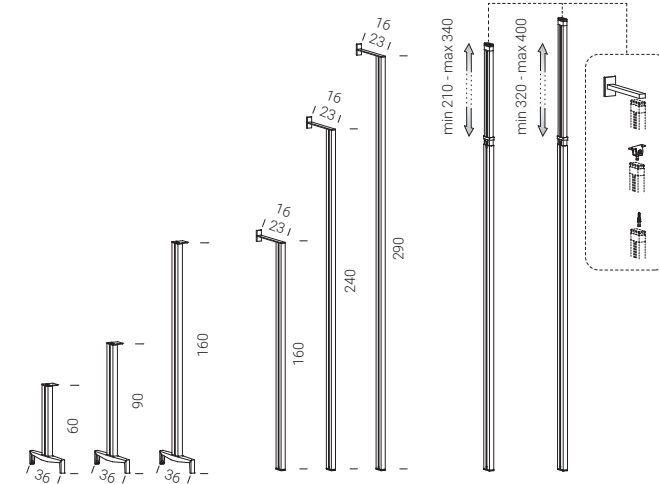

cm disponibili riduzioni a misura / tailor-made reduction available

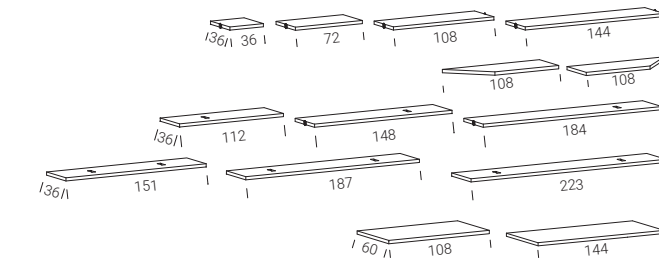

cm disponibili riduzioni a misura / tailor-made reduction available

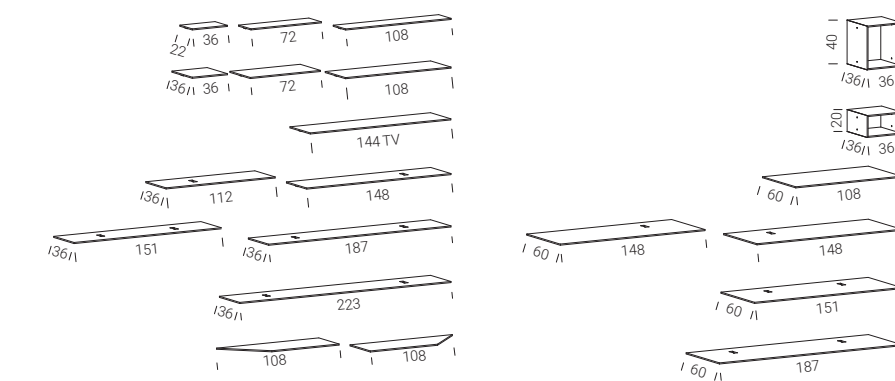

cm disponibili riduzioni a misura / tailor-made reduction available

FINITURE/FINISHES

ripiani in HPL / HPL shelves



POLARIS®



FENIX®



HPL + legno
HPL + wood



HPL laccato
lacquered HPL



contenitori / cabinets

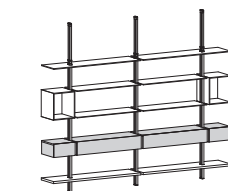

laccato
lacquered



essenze
woods



laccato metallo
metal lacquer



DIMENSIONI/DIMENSIONS

verificare a listino dimensioni e finiture
check dimensions and finishes in the price list

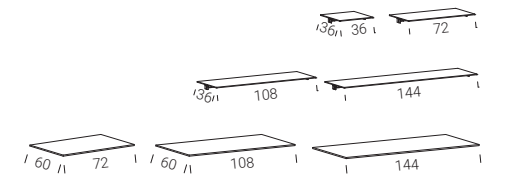

cm disponibili riduzioni a misura / tailor-made reduction available

